

# Data Sheet



Article number: 51503328100010

Description: Vibration damper GP-1I 63x50  
M10, NR shore 57

## Measures

---

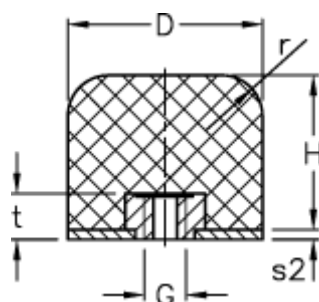

D	= 63	t = 10
d2	= 3	
G	= M10	
H	= 50	
Load capacity F (kN)	= 37.5	
Load capacity f (mm)	= 28	
Load capacity W (J)	= 280	
r	= 12.5	